



# Samsung Air Purifier

## User manual

AX60R5080WD

- Thank you for purchasing this Samsung Air Purifier.
- Before operating this unit, please read this manual carefully and retain it for future reference.



# LOVEAIR

Manuál stažený ze stránek [LoveAir.cz](http://LoveAir.cz)



# SAMSUNG

# Safety Information

---





These safety precautions are for owner's safety and preventions of property damage. Therefore, please read this manual thoroughly before using your product.

## **WARNING**

Hazards or unsafe practices that may result in severe personal injury or death.

## **CAUTION**

Hazards or unsafe practices that may result in minor personal injury or property damage.

-  Follow directions.
-  Do NOT attempt.
-  Make sure the machine is grounded to prevent electric shock.
-  Disconnect from the power source.
-  Do NOT disassemble.

## FOR INSTALLATION

---

### **WARNING**

 **Only connect to a socket that can provide the rated power supply. Do not use the socket with other products. Do not extend the power cord.**

- Using a multi-socket with other products or extending the power cord may cause electric shock or fire.
- Using a voltage converter may cause electric shock or fire.
- Failing to meet the exact voltage, frequency and/or rated current may cause electric shock or fire.

 **Do not install the air purifier near a heat source and inflammable objects, or in areas that are highly humid or dusty. Avoid exposure to oil, gas, direct sunlight and water.**

- Follow instructions to avoid electric shock or fire.

### **CAUTION**

 **When installing the product, make sure that the power plug can be easily removed when needed.**

- Follow instructions to avoid electric shock or fire due to electrical leakage.

**Install the product on a solid flat ground.**

- Follow instructions to avoid excessive vibration, noise and operational issues thereof.



---

**! Keep a safe distance from surrounding objects.**

- Clear space from each side: at least 60 cm and the rear: at least 25 cm
- The space is necessary to ensure efficient air intake and proper purification.
- Make sure that the inlet and outlet are not covered.

**Make sure that the power cord is not pressed under the product.**

- Follow instructions to avoid electric shock or fire.

## FOR POWER SUPPLY

---

**! WARNING**

**! Use a dry cloth to wipe the power plug and the contact area to keep them free from dust, water and other undesirable substances.**

- Follow instructions to avoid electric shock or fire.

**Check the position of the power plug when you connect it to a socket.**

- Having the cord hanging from above the plug may damage the wires inside, which can lead to electric shock or fire.

**Please contact your local Samsung Service Centre if the power plug or cord is damaged.**

**If the supply cord is damaged, it must be replaced by the manufacturer, its service agent or similarly qualified persons in order to avoid a hazard.**

**⊘ Make sure that the power plug is securely fitted in the socket. Do not use it when the plug or cord is damaged.**

- Follow instructions to avoid electric shock or fire.

**When you disconnect the power cord, pull it by the plug. Do not pull the cord itself.**

- Follow instructions to avoid electric shock or fire.

**Do not fold, pull out, twist or tie the power cord. Do not hang it over a metal object or place a heavy object on it. Do not put the cord between objects or behind the air purifier.**

- Follow instructions to avoid electric shock or fire.

**! CAUTION**

**⚡ Remove the power plug of your air purifier when it is not used for a period of time and during a thunderstorm.**

- Follow instructions to avoid electric shock or fire.

**Product installation must be handled by official Samsung service personnel or a certified local technician to avoid power cord or plug damage, which can be dangerous.**

**Disconnect the air purifier from the power source before cleaning or repairing.**



# Safety Information

---

## FOR USING

---

### WARNING

**!** If the product is exposed to water, immediately disconnect it from the power source and contact your local Samsung Service Centre.

- Follow instructions to avoid electric shock or fire.

**If you notice a noise, burning smell or smoke from the product, immediately stop using it and contact your local Samsung Service Centre.**

- Follow instructions to avoid electric shock or fire.

**In the event of a gas leak in proximity of the air purifier, do not touch it or attempt to unplug it. Immediately ventilate the room and contact your provider or a certified technician for advice.**

- Do not turn the ventilation fan on.
- A spark can cause an explosion or fire.

**Do not pull out the power plug while operating the air purifier.**

- This may cause a spark when reconnecting the plug, which can lead to an explosion or fire.

**Please contact your local Samsung Service Centre when you require repair service.**

- Follow instructions to avoid malfunction, water leakage, electric shock or fire.

**⊘ Do not handle the power plug with wet hands.**

- Follow instructions to avoid electric shock or fire.

**Do not use force on the air purifier or pull the unit away.**

- Follow instructions to avoid fire, malfunction or injury.

**Store the plastic package away from children or discard it according to the law.**

- Follow instructions to protect children from a risk of suffocation.

**Do not insert your finger or other objects into the air inlet or outlet.**

- Take special care to protect children from injury.

**Do not place an object near the air purifier as children may use them to climb onto the product.**

- Follow instructions to avoid injury from a tip-over or fall.



---

 **If the power plug area has contacted water, completely dry it before using the air purifier again.**

- Follow instructions to avoid electric shock or fire.

**Do not insert a metal object and similar items inside the air purifier.**

- Follow instructions to avoid electric shock or injury.

**Do not place a heavy object on the air purifier.**

- Follow instructions to avoid malfunction or noise.

 **If any of the electric components inside the air purifier has contacted liquid or water, disconnect the product from the power source and contact your local Samsung Service Centre.**

- Follow instructions to avoid electric shock or fire.

 **Do NOT attempt to repair or modify the product.**

- Use only the standard rated fuse.
- Follow instructions to avoid electric shock, fire, malfunction or injury.

 **CAUTION**

 **Keep your air purifier at least 2 meters away from a TV or other audio/visual media.**

- They can be affected by video or audio noise.

**Secure enough space around the air purifier when operating.**

- Clear space from each side: at least 60 cm and the rear: at least 25 cm
- Your air purifier is designed to take in air through the rear inlet for purification. Keep the area around the inlet clear and make sure that both the inlet and outlet are not covered by any obstacles including curtains.

 **Do not step on the product or place other objects on it (laundry, candles, burning cigarettes, plates, medicine, metal items, air fresheners, etc.).**

- Follow instructions to avoid electric shock, fire, malfunction or injury.

**Do not tilt or flip the air purifier while the power plug is connected to the socket.**

- Follow instructions to avoid malfunction or fire.

**Do not use bug repellent or other spray products on the air purifier.**

- They can be harmful and may cause electric shock, fire or malfunction.

**Do not submerge the air purifier.**

- Follow instructions to avoid malfunction.



# Safety Information

## Do not handle the product with wet hands.

- Follow instructions to avoid electric shock.

**This appliance can be used by children aged from 8 years and above and persons with reduced physical, sensory or mental capabilities or lack of experience and knowledge if they have been given supervision or instruction concerning use of the appliance in a safe way and understand the hazards involved. Children shall not play with the appliance.**

**Cleaning and user maintenance shall not be made by children without supervision.**

## FOR CLEANING

### WARNING

## Do not apply water, benzene, thinner, alcohol, acetone or similar substances directly on the product.

- Follow instructions to avoid product discolouration or deformation, electric shock or fire.

**Disconnect the product from the power source when cleaning. Wait for the fan to completely stop before cleaning.**

- Follow instructions to avoid electric shock or fire.

### CAUTION

## Be sure to disconnect the power plug from the socket before cleaning the product.



### *Correct Disposal of This Product (Waste Electrical & Electronic Equipment)*

#### **(Applicable in countries with separate collection systems)**

This marking on the product, accessories or literature indicates that the product and its electronic accessories (e.g. charger, headset, USB cable) should not be disposed of with other household waste at the end of their working life. To prevent possible harm to the environment or human health from uncontrolled waste disposal, please separate these items from other types of waste and recycle them responsibly to promote the sustainable reuse of material resources. Household users should contact either the retailer where they purchased this product, or their local government office, for details of where and how they can take these items for environmentally safe recycling. Business users should contact their supplier and check the terms and conditions of the purchase contract. This product and its electronic accessories should not be mixed with other commercial wastes for disposal.

For information on Samsung's environmental commitments and product-specific regulatory obligations, e.g. REACH, WEEE, Batteries, visit : [samsung.com/uk/aboutsamsung/samsungelectronics/corporatecitizenship/data\\_corner.html](https://samsung.com/uk/aboutsamsung/samsungelectronics/corporatecitizenship/data_corner.html)

# Detailed User Manual

---

- The product shape is subject to change without prior notification to improve the quality.
- To save precious resources, we are reducing the printed manuals and providing online manuals that can be seen on your smartphone or website.

## Checking on the website

---

**STEP1** Check the model name.

**STEP2** Go to the Samsung website (<http://www.samsung.com>) or Read the QR code.



**STEP3** Search and check User manual. SUPPORT  
> Manuals & Downloads > Search model

## Checking in Service Centre

---

**STEP1** Check the model name.

**STEP2** Contact Service Centre.

**STEP3** Ask for the user manual of your product model.

# SmartThings app

---

Use the SmartThings app on your smartphone to control the air purifier via the wireless Internet. To remotely control the air purifier, you need to connect your smartphone to the air purifier.

**Step 1. Checking the requirements for connection**

**Step 2. Connecting your smartphone to the Wi-Fi network**

**Step 3. Installing the SmartThings app**

**Step 4. Configuring the SmartThings app**

**Step 5. Connecting your smartphone to the air purifier**

**Step 6. Controlling the air purifier with your smartphone**

### NOTE

- For more information about how to install the SmartThings app, connect it to the product, and control the product with it, read the QR code above and refer to detailed instructions in the user manual.

# At a Glance

## Front side

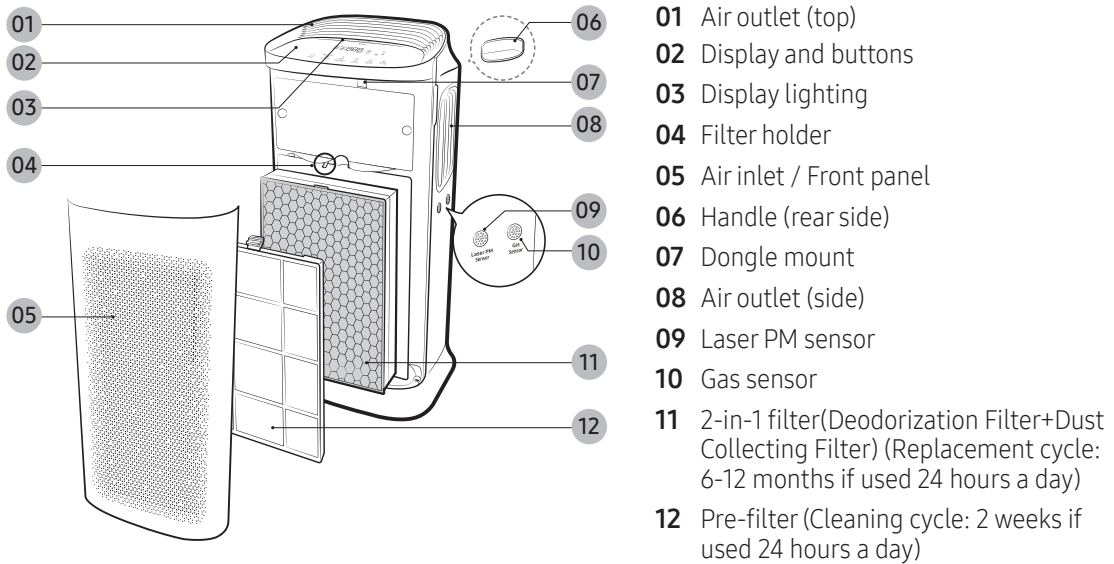

## Buttons

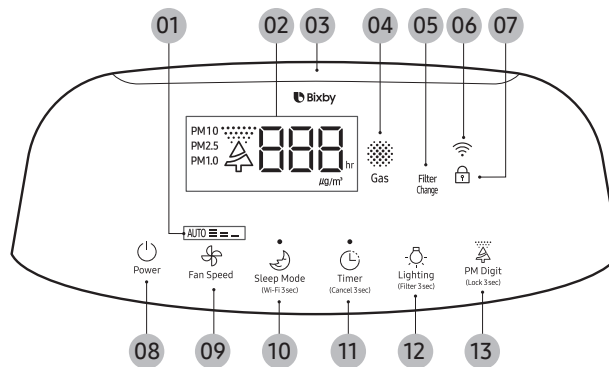

- |   |  |
|---|--|
| <p>01 Current fan speed</p> <p>02 PM10 / PM2.5 / PM1.0 pollution / Concentration / Timer indicator</p> <p>03 Air quality indicator</p> <p>04 Gas pollution indicator</p> <p>05 Filter replacement reminder</p> <p>06 Wi-Fi function indicator</p> | <p>07 Lock indicator</p> <ul style="list-style-type: none"> <li>• If there are any kids, operate it with the Lock enabled.</li> </ul> <p>08 Power button</p> <p>09 Fan speed button</p> <p>10 Sleep mode / Wi-Fi On or Off button</p> <p>11 Timer on/off button</p> <p>12 Lighting / Filter reset button</p> <p>13 Air quality / Lock button</p> |
|---|--|



## Checking the air quality

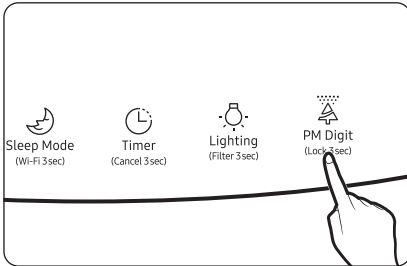

You can review the current air quality from the display panel with the colour (reflecting the PM10 / PM2.5 / PM1.0 / gas pollution) and the concentration level indicators.

- Each time you press the Air quality [PM Digit (Lock 3sec)] button, the current state is displayed in the order of PM10 → PM2.5 → PM1.0. The PM2.5 and PM1.0 levels are displayed for 10 seconds, before automatically changes to the PM10 level.
  - The air quality will be 'Very Poor' when the PM2.5 / PM1.0 levels are worse than the PM10 level. If the concentration levels are same for all PM groups, the indicator will reflect the PM10 level.
- Air quality levels

Pollution level		PM10 concentration (µg/m <sup>3</sup> )	PM2.5 / PM1.0 concentration (µg/m <sup>3</sup> )	Gas pollution level
Very poor	Red	151 and over	76 and over	4
Poor	Yellow	81 - 150	36 - 75	3
Moderate	Green	31 - 80	16 - 35	2
Good	Blue	30 and below	15 and below	1

- PM10, PM2.5 and PM1.0 measurement will be displayed in numbers 05 – 999.

## Checking before Use of Filter

- If you operate the air purifier with no filter, its purification effect decreases.
- At the initial stage of use, new filters may smell bad a little.
  - If you operate it for a day, the smell disappears.
- If you operate the air purifier after 2 weeks or more or bad odour comes out, set the fan speed to High and run the air purification for at least 4 hours while ventilating the area.
- Close windows and doors during operation. Periodically ventilate the air to avoid high concentration of carbon dioxide when the room is closed for a long time.
- The cycles for filter cleaning and replacement may differ depending on the environment. You are charged for the service.
- The indicator illuminates to notify when the filters need to be replaced. However, if the filters are too dirty or smells bad or the fan speed is lowered rapidly, replace them with new ones even if the indicator does not illuminate.
- In case of first use or replacement, be sure to remove the vinyl from filters.

# Cleaning and Maintenance

## Cleaning the sensors

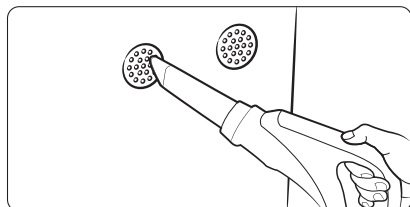

- If there is dust or foreign substance on a sensor, use a vacuum cleaner to clean the sensor and its surrounding.

## Cleaning and drying the front panel

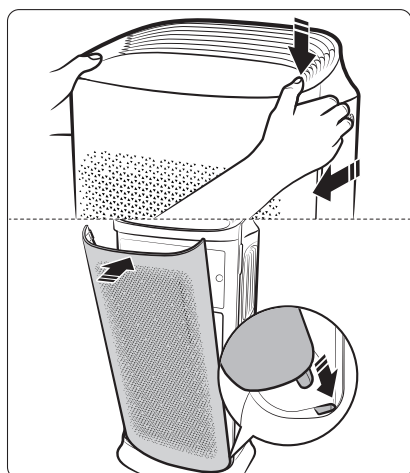

**STEP1** Remove the front panel.

- Use your thumbs to press on the top of the product and pull the front panel forward with other fingers.

**STEP2** Clean and dry the front panel.

- Clean any dirt or foreign substance on the front panel with water or a soft cloth.
- After cleaning with water, thoroughly dry the front panel before reassembling it to the product.

**STEP3** Reassemble the front panel.

- First, insert the hook on the panel into the groove at the bottom of the product.

## Cleaning and drying the filters

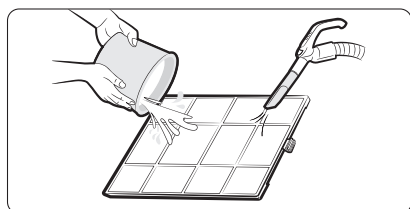

**Cleaning the pre-filter**

- If you can see dust accumulations, remove large dust first with a vacuum cleaner, and then rinse the filter with lukewarm water.
  - Cleaning interval: 2 weeks (when using the product 24 hours every day)

**Drying the filters**

- Keep the filters in the shade until completely dry and away from direct sunlight.

# Before Requesting Service

## The air purifier does not operate.

- Make sure that the front panel is closed properly. If you hear a “beep” or “ring ring” sound when the front panel is opened and closed, it indicates that the panel is closed completely.

## There is no change in air pollution level on the display.

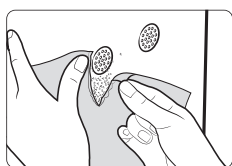

- To check if the sensor is functioning, test it by tearing paper by the sensor and/or rub them to create some dust. This will cause the PM levels to change if the sensor is working properly.
- The gas sensor reacts to changes in the indoor odourant level due to cooking or ventilation, causing the indicator to illuminate in red. When this happens, ventilate the room for 1 to 2 hours.
- Disconnect the power plug, then put it back after 1 minute.
- The dust concentration may vary depending on the operating environment.
  - Construction site, road area, use of vacuum cleaner, organizing of quilts/clothes, fabric sofa area, etc.
- The gas pollution reading can be affected by odorous household items such as air fresheners, deodorants and detergents.
- If you are using more than one air purifier in the same room, the dust concentration reading on each unit may not be same as they affect air circulation. The dust concentration reading may vary depending on the sensor or product being used.
- When humidifiers, electric pressure cookers, sprayers and such are being used in the same room, the pollution level may be measured as Poor.

## The pollution level indicator does not seem to work.

- Check the sensors for any foreign substances and clean them if necessary.

- During initial operation after shipping or installation in winter, dew condensation may occur inside the sensor due to the temperature difference between inside and outside, which may cause the dust concentration to temporarily display high or the air pollution indicator may light up in red. The status will be cleared within 1 to 2 hours of operation.

## The air purifier makes strange noises.

- If you move the product during operation, it may cause noise. Turn off the power before moving the product.

## The air purifier smells strange.

- If you operate the product after using an air freshener, a diffuser, a scented candle, or a cleaning agent, or making interior decoration, or replacing wallpaper, odours may be saturated to the filters, making them smell.
- Because the air purifier sucks and circulates indoor air, if you use it in a closed space for a long time, odours generated in your home can saturate the filters.
  - Remove the filter and then smell it nearby. If it smells, clean the micro filter and replace the replacement filter with a new one.
  - Open the doors and windows, and then operate the product for 3 to 4 hours.
  - If you grill fish or meat or cook with oil, operate the product after most odours have been removed by ventilation.
- In a room with persisting odours, using the product after ventilating the room first allows more effective odour control.
- In a humid place, the filter may smell. Dry the replacement filter sufficiently in the sun before operation.

## The filter replacement reminder stays on.

- After replacing with a new one, be sure to perform Filter Reset to clear the filter replacement reminder.

# Reference

Wi-Fi	
<sup>1)</sup> Frequency Range	<sup>2)</sup> Transmitter Power (Max)
2412 - 2472 MHz	20 dBm

English	<sup>1)</sup> Frequency Range <sup>2)</sup> Transmitter Power(Max)
French	<sup>1)</sup> Plage de fréquence <sup>2)</sup> Puissance de l'émetteur (Max.)
Italian	<sup>1)</sup> Intervallo frequenza <sup>2)</sup> Potenza trasmettitore (Max)
Polish	<sup>1)</sup> Zakres częstotliwości <sup>2)</sup> Moc nadajnika (maksymalna)
Dutch	<sup>1)</sup> Frequentiebereik <sup>2)</sup> Zendvermogen (max.)
Bulgarian	<sup>1)</sup> Честотен диапазон <sup>2)</sup> Мощност на предавателя (макс.)
Romanian	<sup>1)</sup> Gama de frecvență <sup>2)</sup> Puterea transmițătorului (Max.)
Hungarian	<sup>1)</sup> Frekvenciartomány <sup>2)</sup> Jeladó teljesítmény(Max)
Czech	<sup>1)</sup> Frekvenční rozsah <sup>2)</sup> Výkon vysílače (max.)
Slovak	<sup>1)</sup> Frekvenčný rozsah <sup>2)</sup> Výkon vysílača (max.)



---

English	Hereby, Samsung Electronics, declares that the radio equipment type appliance is in compliance with Directive 2014/53/EU. The full text of the EU declaration of conformity is available at the following internet address: The official Declaration of conformity may be found at <a href="http://www.samsung.com">http://www.samsung.com</a> , go to Support > Search Product Support and enter the model name.
French	Par la présente, Samsung Electronics déclare que cet appareil de type équipement radio est en conformité avec la Directive 2014/53/UE. Le texte intégral de la déclaration de conformité de l'UE est disponible à l'adresse Internet suivante: La Déclaration officielle de conformité se trouve sur <a href="http://www.samsung.com">http://www.samsung.com</a> , rendez-vous sur la page d'assistance > Rechercher dans l'Assistance et saisissez un nom de modèle.
Italian	Samsung Electronics dichiara che l'apparecchiatura radio aderisce alla direttiva 2014/53/EU. Il testo integrale della dichiarazione di conformità EU è disponibile al seguente indirizzo: La dichiarazione ufficiale di conformità è disponibile su <a href="http://www.samsung.com">http://www.samsung.com</a> , selezionare supporto > Cerca Supporto Prodotto e inserire il nome del modello.
Polish	Firma Samsung Electronics niniejszym oświadcza, że sprzęt radiowy jest zgodny z wymogami Dyrektywy 2014/53/UE. Pełny tekst europejskiej deklaracji zgodności jest dostępny na stronie internetowej: Treść oficjalnej deklaracji zgodności jest dostępna pod adresem <a href="http://www.samsung.com">http://www.samsung.com</a> w menu Wsparcie > Szukaj, gdzie należy podać nazwę modelu.
Dutch	Samsung Electronics verklaart hierbij dat het type radiotoestel voldoet aan Richtlijn 2014/53/EU. De volledige tekst van de EG-Conformiteitsverklaring vindt u op deze website: De officiële Conformiteitsverklaring vindt u op <a href="http://www.samsung.com">http://www.samsung.com</a> , ga naar Ondersteuning > Productondersteuning zoeken en voer de modelnaam in.



# Reference

Bulgarian	<p>С настоящия документ Samsung Electronics декларира, че уредът от тип радиооборудване е в съответствие с Директива 2014/53/ЕС. Целият текст на ЕС Декларацията за съответствие е наличен на следния интернет адрес: Официалната Декларация за съответствие можете да намерите на <a href="http://www.samsung.com">http://www.samsung.com</a>, отидете на отидете на поддръжка &gt; Търсене на поддръжка за продукт и въведете името на модела.</p>
Romanian	<p>Prin prezenta, Samsung Electronics declară faptul că aparatul de tip echipament radio respectă Directiva 2014/53/UE. Textul complet al declarației de conformitate UE este disponibil la una dintre următoarele adrese de internet: Declarația de conformitate oficială poate fi găsită la <a href="http://www.samsung.com">http://www.samsung.com</a>, accesați asistența &gt; Căutați asistența produsului și introduceți numele modelului.</p>
Hungarian	<p>A Samsung Electronics ezennel kijelenti, hogy a rádiós berendezés típusú készülék megfelel a 2014/53/EK irányelv előírásainak. Az EU megfeleléségi nyilatkozat teljes szövege az alábbi weboldalon olvasható : A hivatalos Megfeleléségi nyilatkozat a <a href="http://www.samsung.com">http://www.samsung.com</a> honlapon olvasható, lépjen a Támogatás &gt; Terméktámogatás keresése menüpontra, és adja meg a modell nevét.</p>
Czech	<p>Společnost Samsung Electronics tímto prohlašuje, že uvedené rádiové zařízení vyhovuje požadavkům směrnice 2014/53/EU. Úplné znění EU Prohlášení o shodě je k dispozici na následující internetové adrese: Oficiální prohlášení o shodě naleznete na webu <a href="http://www.samsung.com">http://www.samsung.com</a>, kde klepněte na odkaz Podpora a do pole Hledat Podporu zadejte název modelu.</p>
Slovak	<p>Spoločnosť Samsung Electronics týmto vyhlasuje, že zariadenie rádiového typu je v súlade so smernicou 2014/53/EÚ. Celé znenie Vyhlásenia o zhode EÚ je k dispozícii na nasledujúcej internetovej adrese: Oficiálne Vyhlásenie o zhode sa nachádza na lokalite <a href="http://www.samsung.com">http://www.samsung.com</a>, prejdite na položky Podpora &gt; Vyhľadávanie podpory produktov a zadajte názov modelu.</p>



# Memo

---



LOVEAIR

Manuál stažený ze stránek [LoveAir.cz](http://LoveAir.cz)

